

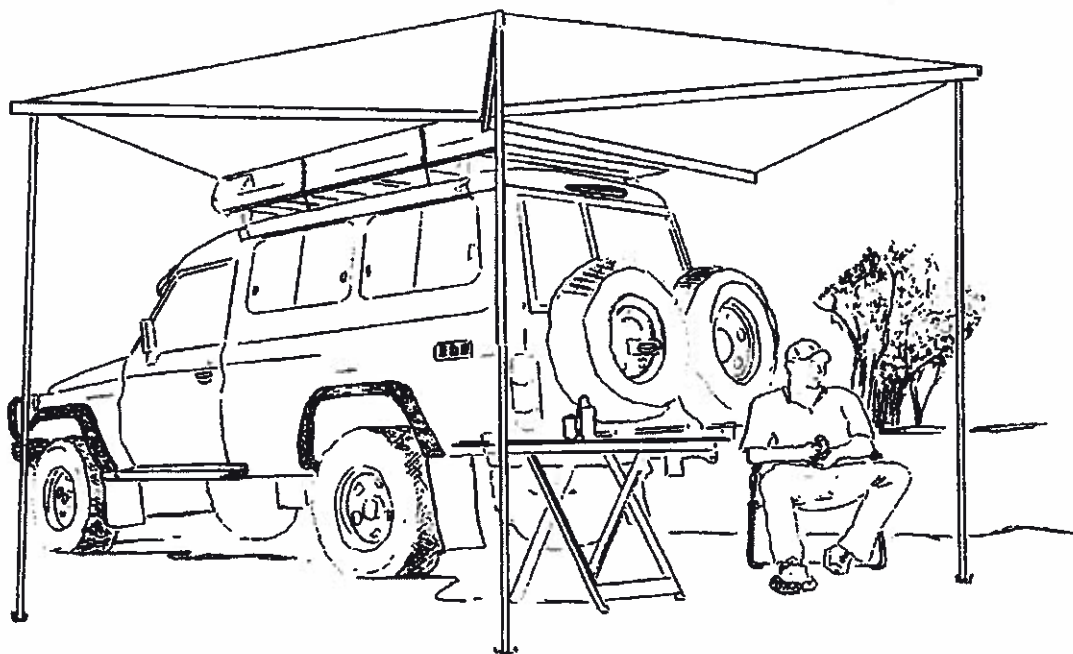

OPERATING INSTRUCTIONS

P.O. Box 68323, Bryanston 2021.
200 Cussonia Park, 3 Ridge Road,
Laser Park, Honeydew, South Africa.
Tel: (011) 794-6311 • Fax: (011) 794-6233



HELPFUL HINTS

1. Periodically clean the fabric with water. (Let the fabric dry before rolling it up. This also helps prevent mildew.)
Cleaning is especially important prior to storing the awning for long periods of time to prevent mildew and stains.
2. Use paraffin wax on Support Arms and Rafter Arms for smoother sliding movement.

TO OPEN

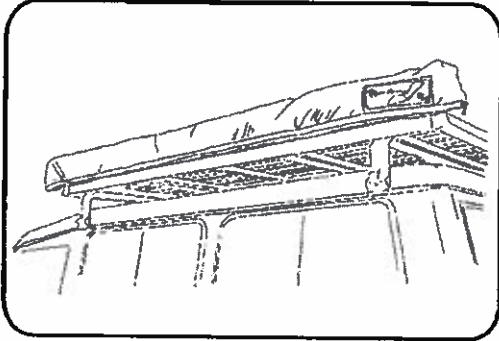

BAT in closed position

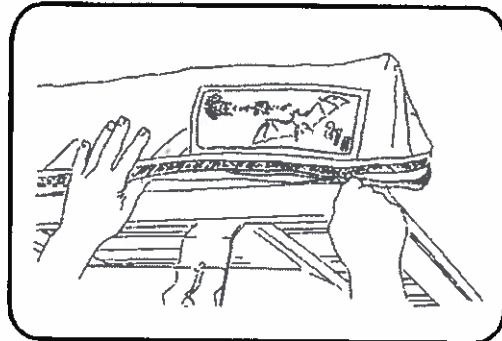

Unzip bag in order to open the BAT

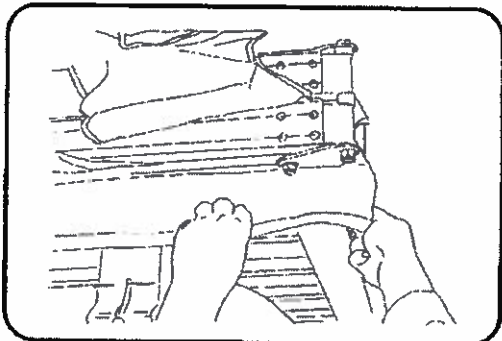

Fold bag back on the hinge side first

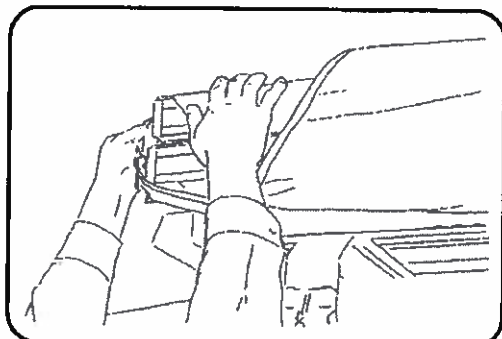

Fold bag back on profile side and loosen retaining strap

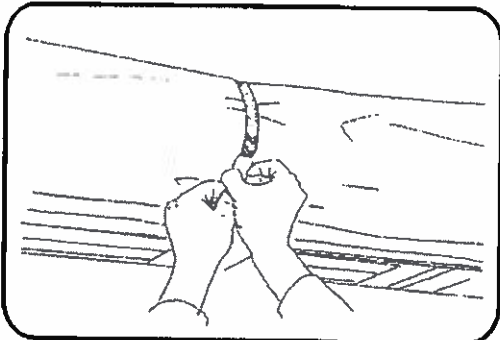

Undo all plastic clips that are retaining fabric in place

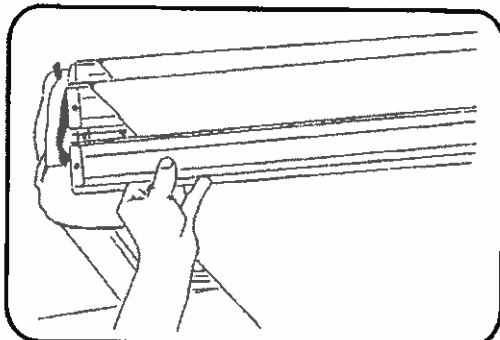

Take hold of aluminium profile

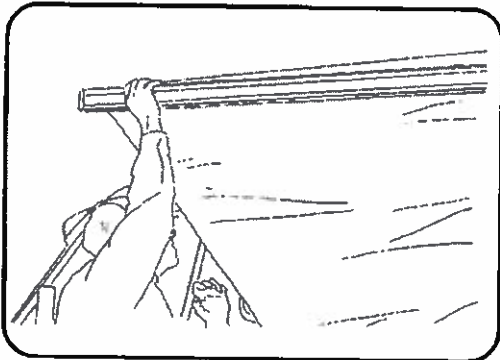

Pull on aluminium profile to release BAT

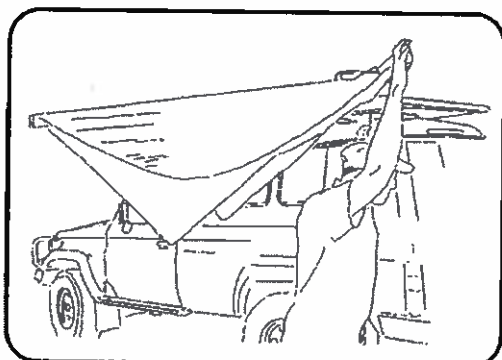

Walk with the profile in your hand in order to deploy the BAT

TO OPEN

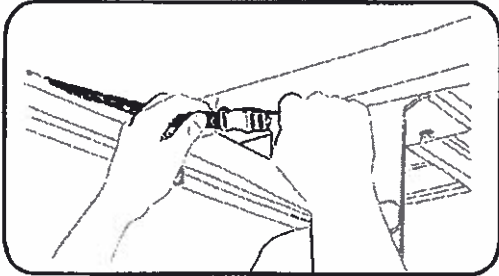

Secure strap provided to your roofrack or bars and then adjust one end by pulling on the strap

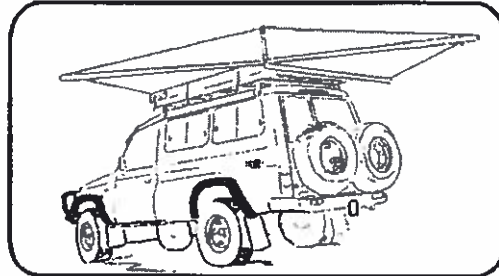

BAT in open position without legs deployed.
NB: The BAT must only be deployed in this manner in fair weather

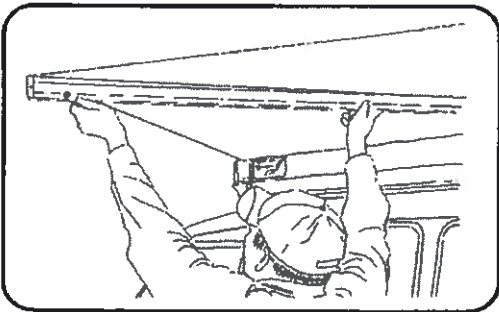

Loosen black button on leg and slide out

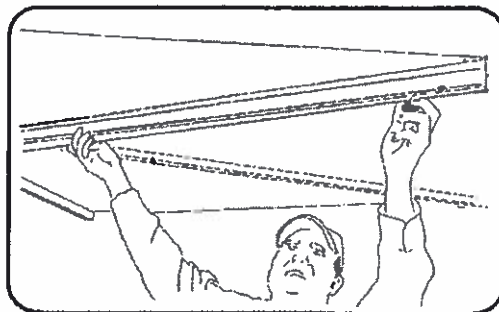

Drop the three BAT legs out from aluminium profile

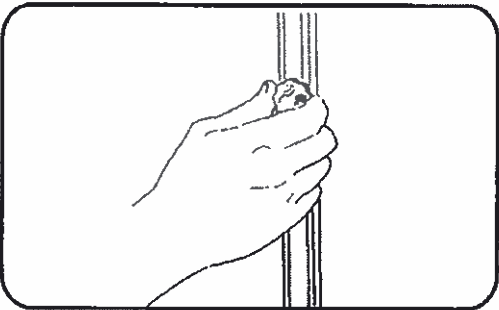

Adjust to correct height and secure black button

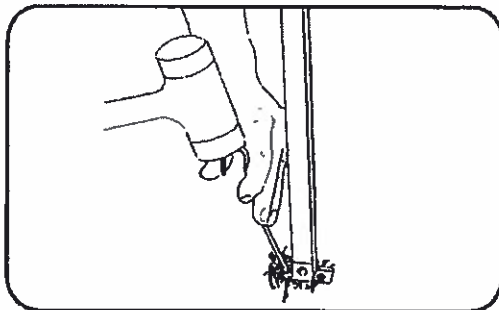

Secure BAT awning leg with pegs provided

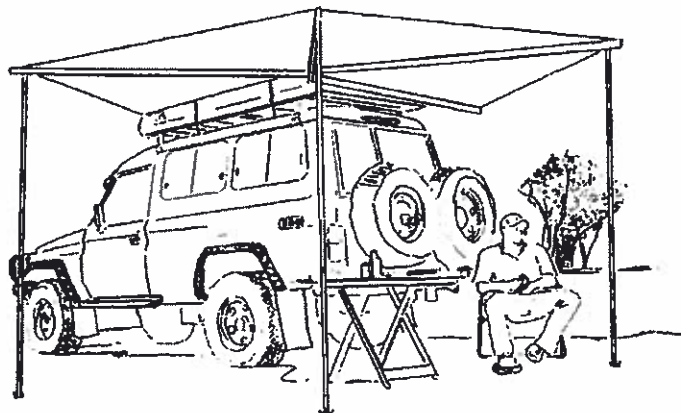

RELAX AND ENJOY!!!

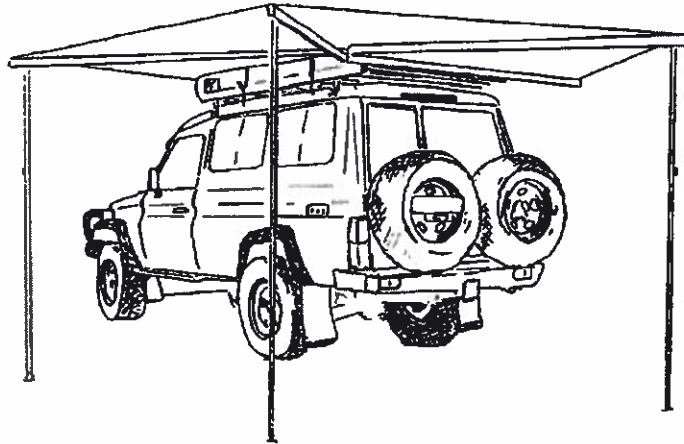

Legs must be deployed and anchored in wind and rain

TO CLOSE

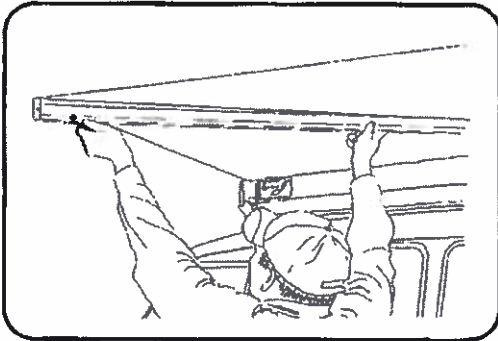

Replace awning legs back into aluminium profile

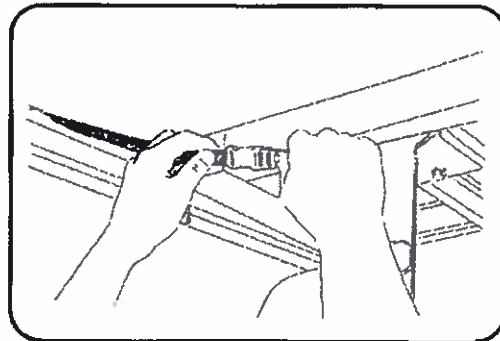

Undo plastic clip on retaining strap

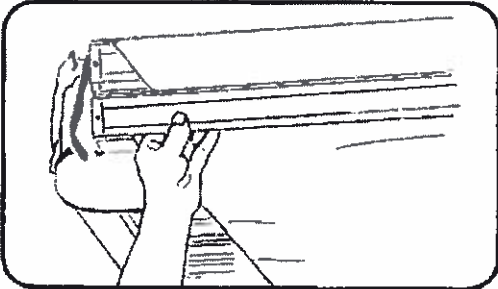

Fold aluminium profiles back into storage position - help guide them so that they sit on top of one another and secure with strap provided

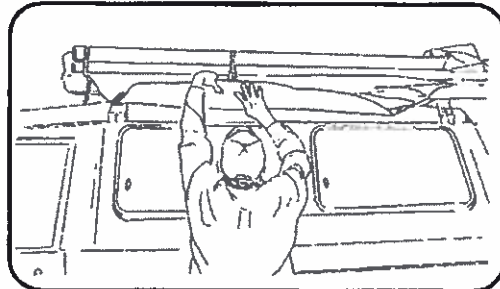

Roll fabric back up and secure with strap provided

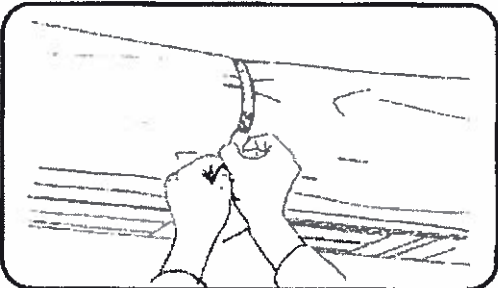

Secure fabric with strap provided



Help with one hand to push fabric in place and close zip



INSTALLATION

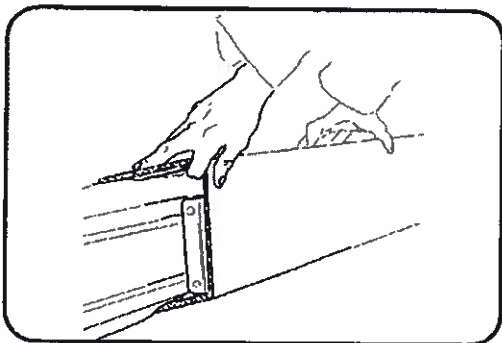

Remove BAT 270 from its packaging and place it face down

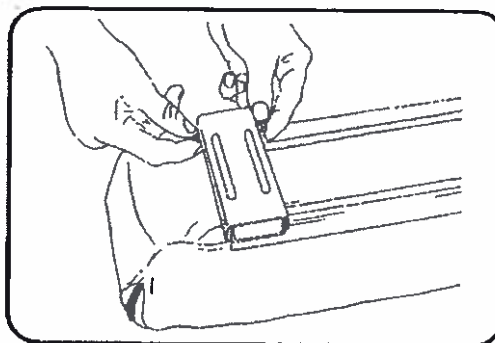

Undo top bracket of kit provided

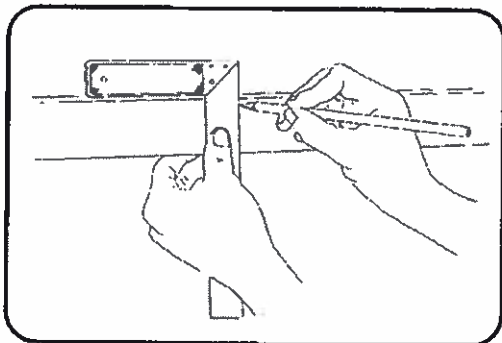

By using a set square, draw a straight line where you would like to mount the front kit to the roofrack

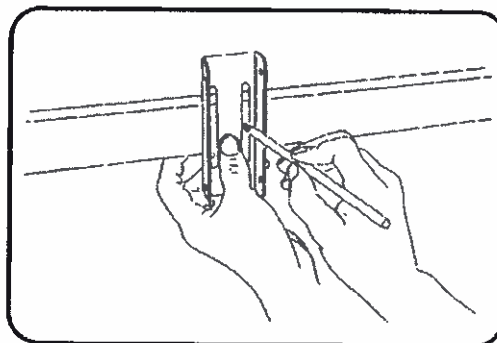

Place the kit into position and mark the holes on the roofrack

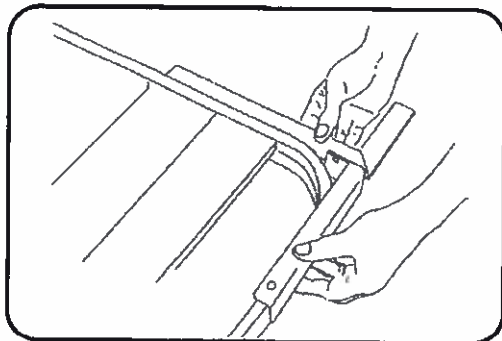

If the roofrack has round corners place the long kit provided into position in a line with a set square and side of rack (this kit should be mounted on the hinge side of your BAT)

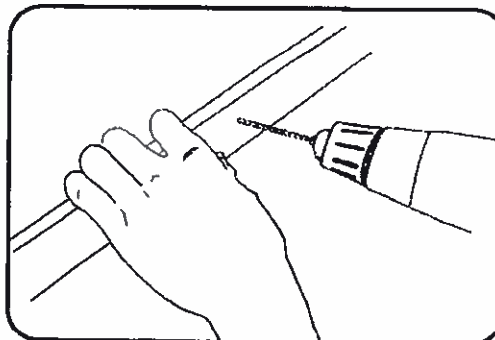

Drill holes in rack by using a 6.5mm drillbit



INSTALLATION

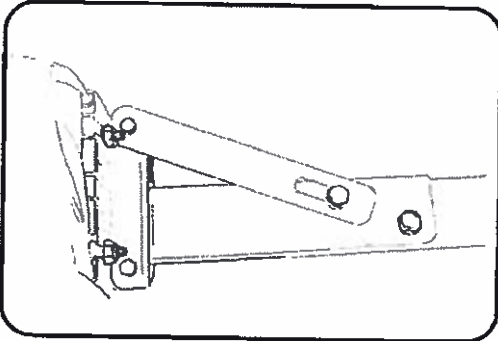

Bolt brace and large bracket to roofrack and secure

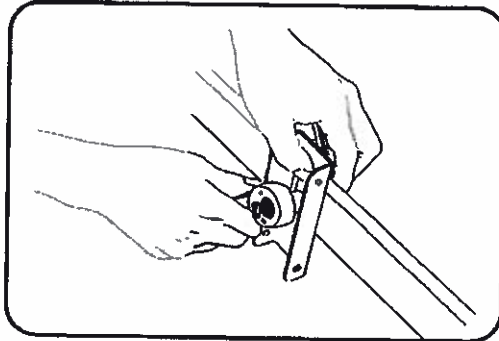

Fix brackets with bolts provided

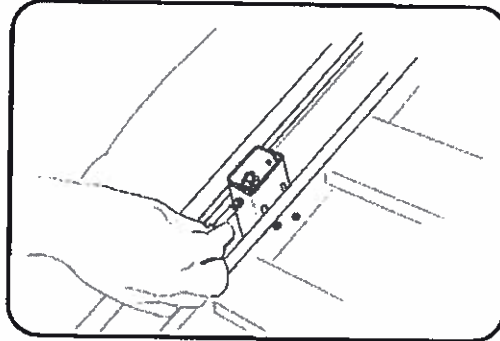
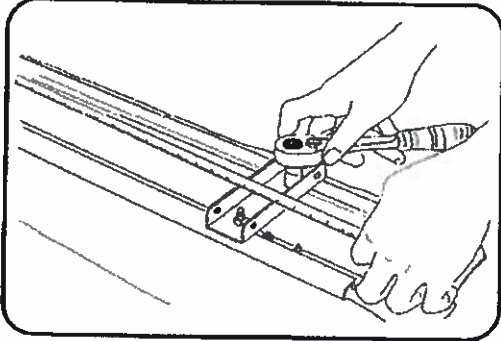

Use a measuring tape to align the kits on the back of the BAT 270 with the ones you have now fitted to your rack. Do this by loosening the bolts on the kit. The one without the "Do not remove sticker" on and slide it to the measurement required. Hold the BAT in position and bolt the two kits together

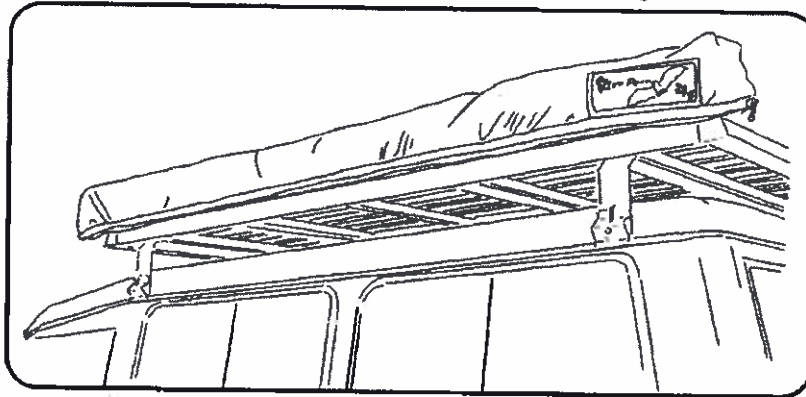

A JOB WELL DONE!!!